

TÖYÖTÖMI

PORTABLE KEROSENE HEATER OPERATION AND MAINTENANCE INSTRUCTIONS

Model **RCA-37 (Type B)**

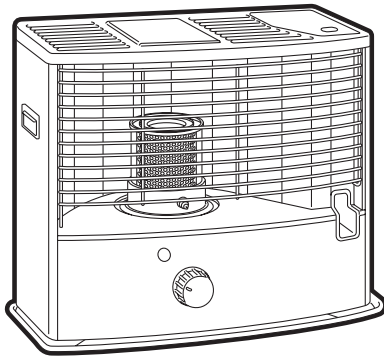

IMPORTANT

READ AND UNDERSTAND INSTRUCTIONS BEFORE USING HEATER.

RETAIN INSTRUCTIONS FOR FUTURE REFERENCE.

This heater is designed to be used at altitudes up to 1,300m above sea level. Consult with your dealer otherwise.

CONTENTS

SAFETY TIPS	1	REPLACEMENT OF PARTS	10
FUEL GUIDE	3	STORAGE	13
ASSEMBLY AND OPERATION	4	SPECIFICATIONS	13
CARE AND MAINTENANCE	9	COMPONENT PARTS	14

SAFETY TIPS

BEFORE OPERATING YOUR HEATER, PLEASE review these safety tips:

⚠ WARNING

RISK OF EXPLOSION

1. NEVER use any fuel other than clean kerosene (paraffin). NEVER use gasoline (petrol). Use of gasoline (petrol) can lead to uncontrollable flames resulting in destructive fire. Even kerosene (paraffin) contaminated with small amounts of gasoline (petrol), or similarly volatile materials, can be hazardous. Never use a can for kerosene (paraffin) that has previously been used for gasoline (petrol), paint thinner, methylated spirit, or solvents.
2. The appliance is to be used only with paraffin, class C1 burner fuel in accordance with BS 2869.
3. NEVER refill heater fuel tank when heater is operating or still hot. To do so may cause a “flash back” of flame to the fuel container, resulting in injury to yourself and your property.
4. NEVER use heater in areas where flammable vapors or gases may be present. Especially avoid use of heater where gasoline (petrol), naphtha, acetone or other volatile solvents are in the air, or whose containers are open. Such vapors could be ignited by the heater, resulting in fire and/or explosion.
5. NEVER fill heater fuel tank in living space. Fill heater tank outdoors. Never overfill your heater. Always replace heater tank cap securely after refueling. Spillage of kerosene (paraffin) produces strong odor which is hard to remove. Spillage on carpet can be ignited if match or some other ignition source contacts it.
6. NEVER store or transport kerosene (paraffin) in other than a metal or plastic container that is (1) acceptable for kerosene (paraffin), (2) non-red in color, and (3) clearly marked, “KEROSENE (PARAFFIN)”. Never store kerosene (paraffin) in the living space. Picking up a gasoline (petrol) can by mistake when fueling is a major cause of heater fires. Store the kerosene (paraffin) out of reach of children in a safe container, marked “KEROSENE” (“PARAFFIN”).

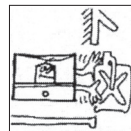
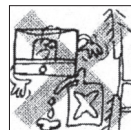
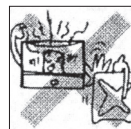
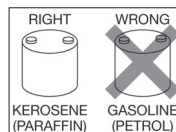

⚠ WARNING

RISK OF BURNS OR FIRE

1. Observe the heater carefully for 15-20 minutes after start-up. Problems of improper adjustment of wick height or improperly seated heat chamber should become evident during this warm up period.

NOTE: Carefully follow the instructions for lighting and adjusting the flame.

2. Due to high surface temperatures, keep away from children, furniture and clothing.

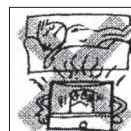

3. DO NOT use heater to heat or boil water or as a cooking appliance.
DO NOT place cooking utensils, tea kettles or any other object on top of heater while in operation.
4. To avoid possible burns or fire, do not move, refuel or attempt to service your heater while it is burning or still hot. If the heater is dropped while it is burning, fuel spillage and flames outside the heater may occur.
5. DO NOT operate heater less than one (1) meter from walls, draperies, clothing, or furniture. The operation of any heating appliance too close to such materials could cause them to ignite, possibly resulting in a serious fire.
6. To avoid unstable burning, do not operate your heater in areas exposed to strong drafts.
DO NOT operate heater in high-traffic areas such as doorways or hallways where it may be touched, jarred or tipped accidentally.
7. DO NOT operate heater in direct sunlight to avoid overheating, which may cause abnormal flame behavior.
DO NOT allow room temperature to go above 25°-30°C. If the room temperature exceeds 25°-30°C the flame may increase, thereby producing smoke.
8. Before going out, or at bedtime, turn the heater off, making sure the wick is in its lowest position (see Extinguishing the Flame on page 8) and flame is completely extinguished.

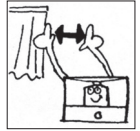

⚠ WARNING

RISK OF INDOOR AIR POLLUTION

Use heater only in well-ventilated areas. People with breathing problems should consult a physician before using the heater.

"In a house of typical construction, that is, one that is not of unusually tight construction due to heavy insulation and tight seals against air infiltration, an adequate supply of air for combustion and ventilation is provided through infiltration. However, if the heater is used in a small room where less than 5.7m³ (200 cubic feet) of air space is provided for each 1000 Btu per hour of heater rating (considering the maximum burner adjustment), the door(s) to adjacent room(s) should be kept open or a window to the outside should be opened at least 25 mm (1 inch) to guard against potential buildup of indoor air pollution. DO NOT use the heater in a bathroom or any other small room with the door closed."

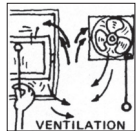

FUEL GUIDE

The RCA-37 (Type B) is designed for use with high-quality kerosene (paraffin). Use of low-quality kerosene (paraffin) will cause wick performance to drop, leading to “low flame” and “odor problem” conditions.

The kerosene commonly known as “industrial kerosene (paraffin)” is not suitable for your heater.

Purchase only kerosene (paraffin) in non-red cans reserved exclusively for kerosene (paraffin) and marked accordingly with the word “KEROSENE (PARAFFIN)”. Always store your kerosene (paraffin) in a separate area from where you store gasoline (petrol) for your power equipment, to avoid accidental use of gasoline (petrol) in your heater.

What to Buy...

- ALWAYS: Crystal clear, colorless, high quality KEROSENE (PARAFFIN).
- ALWAYS: Kerosene (paraffin) free of contaminants, water or cloudiness.
- NEVER: Gasoline (petrol), alcohol, white gas, camp stove fuel or additives.
- NEVER: Yellow or sour-smelling fuel.

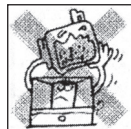

How to Use It...

- ALWAYS: Fill heater away from living quarters when heater is cool; use siphon.
- ALWAYS: Check wick frequently for tar build-up. (Rapid, heavy build-up may indicate poor quality or deteriorated fuel.)
- ALWAYS: Watch fuel gauge to avoid over-filling heater.

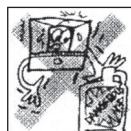

How to Store It...

- ALWAYS: In a clean container, clearly marked KEROSENE (PARAFFIN).
- ALWAYS: AWAY FROM direct sunlight, heat sources or extreme temperature changes.
- NEVER: In a glass container, or one that has been used for other fuels.
- NEVER: For longer than 6 months. (Begin each heating season with fresh kerosene (paraffin); discard at the end of the season.)
- NEVER: Accidental introduction of water into fuel containers.



Why It is Important...

Pure, clean kerosene (paraffin) is essential for safe and efficient heater operation. Poor quality or contaminated kerosene (paraffin) can cause:

- Low flame
- Excess tar deposits on the wick
- Reduced wick life
- Odor, smoke
- Difficulty in igniting or extinguishing flame

Use of a highly volatile flammable fuel such as gasoline (petrol) can produce uncontrollable flames, creating a severe fire hazard.

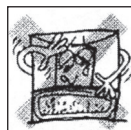

CAUTION

Flames observed emerging from the heater body are a clear indication that fuel is dangerously contaminated with gasoline (petrol) or other highly flammable material. If this occurs,

- a. NEVER attempt to move the heater.
- b. Call the Fire Department.
- c. Use only a class “B” fire extinguisher.
- d. NEVER throw water directly on a burning heater.

ASSEMBLY AND OPERATION

INSPECTION AND ASSEMBLY

NOTE: Please save the shipping carton and packing materials for future storage of your heater.

1. REMOVE PACKING MATERIALS

Open the grille by raising the lower right hand corner of grille and pulling straight out. Slide the cardboard packing down by spreading out to release the heat chamber assembly. Lift the heat chamber, in its protective packing, out of the cabinet.

2. REPLACE THE HEAT CHAMBER

Remove the cardboard packing, and replace the heat chamber assembly. Point the wire handle to the front of the heater.

Close the grille.

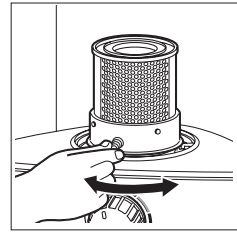
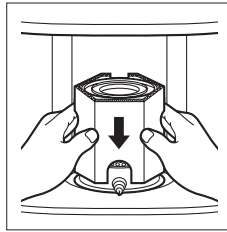
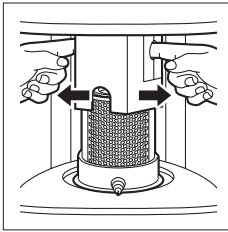

3. INSTALL THE BATTERIES

Locate the battery holder on the back of your heater.

- Insert the battery 4 "C" size batteries according to the plus (+) and minus (-) markings.

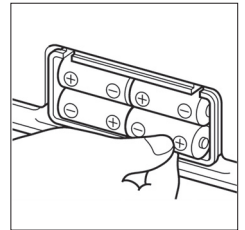

4. CHECK THE HEAT CHAMBER

If the chamber is raised, put it down and inlay it.

NOTE: If the heat chamber is raised, it can cause smoke and soot.

FUELING

⚠ WARNING: Use only clean kerosene (paraffin).

NEVER use gasoline (petrol) or other flammable liquids.

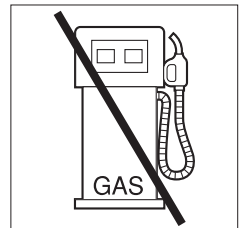

1. Open the fuel tank lid on the top of heater cabinet and lift out the removable fuel tank. Turn the removable tank upside down and remove the fuel tank cap.
2. Insert the straight tube of the manual siphon into the kerosene container. Insert the siphon's flexible hose into the removable fuel tank opening.
3. Turn the air vent knob on the top of the siphon clockwise to close the vent. Start the flow of kerosene by squeezing the bulb of the siphon vigorously six or seven times. Once flow begins, it is no longer necessary to squeeze the bulb.
4. Watch the fuel gauge on the removable tank to avoid overfilling. When it shows half, stop flow by turning the air vent knob counterclockwise.

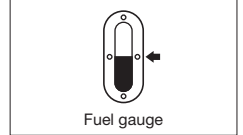
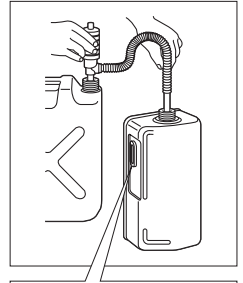

NOTE: Be careful to avoid overfilling the tank, especially with very cold kerosene. Overflow might occur due to expansion when the fuel warms up.

5. Remove the siphon carefully, allowing excess kerosene to drain from the tube back into the container. Replace fuel tank cap and tighten it securely. Be sure to wipe away any spilled kerosene from tank and other heater parts.
6. After making sure fuel tank cap is tightly fastened, invert tank and replace into heater body.

CHECK BEFORE LIGHTING

1. LEVEL THE HEATER

The heater should be operated on a firm, level floor.

NOTE: If your heater is not level, change locations.
DO NOT prop it with books or other objects.

2. ENGAGE THE AUTOMATIC EXTINGUISHER

The automatic extinguisher is engaged automatically by turning the wick adjuster knob clockwise.

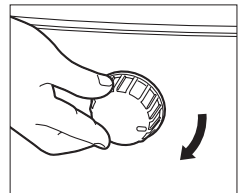

LIGHTING

NOTE: When you first use your new heater, ignite it out of the living area of your house, either in a garage or on area outside protected from strong drafts. Burn it for about 15 minutes to remove all of the protective oil present on the burner parts. If this 15 minutes “burn-in” is done inside, some objectionable odor will be observed. This procedure is necessary **ONLY THE FIRST TIME** you ignite your heater.

NOTE: If you have fueled your heater for the first time, or if you are refueling it after it has been out of fuel for a long time, you will need to wait about 30 minutes for the wick to become fully saturated.

1. Turn the wick adjuster knob clockwise until it stops.

It makes a spark discharge sound in the process of lighting procedure, but turn the wick adjuster knob clockwise until it stops.

As the wick rises within the heater, the wick adjuster knob turns with some resistance and makes a sound like the winding of a clock. Once the wick has reached its proper height, the automatic extinguisher is fully engaged.

The wick adjuster knob can now move freely left or right to adjust the flame.

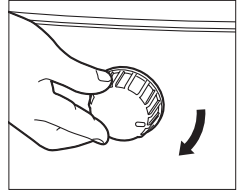

2. LIGHTING WITH A MATCH

You should not have to light the heater with a match, but should it become necessary, open the grille, lift the heat chamber up by holding the wire handle and touch the match to the top of the wick.

DO NOT allow burned parts of the match to fall or remain on the wick.

NOTE: To restore the automatic igniter system to proper operation, replace worn out batteries.

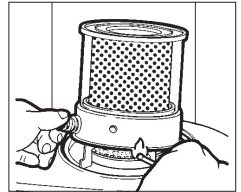

3. Be sure that heat chamber is properly seated by moving the wire handle left and right. If the movement is cough and jerky, it indicates that the heat chamber has not seated properly.

NOTE: An improperly seated heat chamber can cause high flame, smoke, and potential damage to the heater itself.

DO NOT leave the heater until you have determined that the flame is burning normally, which will be described in the following section.

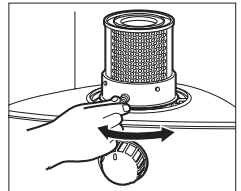

ADJUSTING THE FLAME

1. After lighting, wait for the heat chamber to reach operating temperature. This will take several minutes, then the flame will be visible.

2. CHECK THE FLAME HEIGHT

After five minutes, the entire heat chamber should be glowing red.

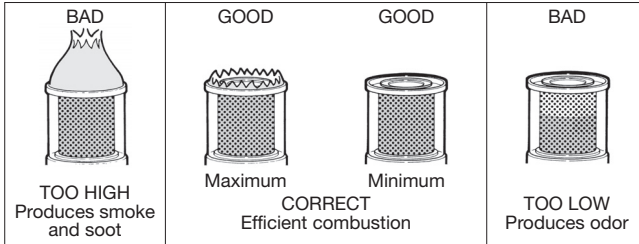

If necessary, raise or lower the wick by turning the wick adjuster knob to produce the proper flame condition.

NOTE: DO NOT operate your heater wick set TOO LOW or TOO HIGH. Doing so will decrease combustion efficiency and increase production of unwanted emissions. When operating heater, be sure wick is high enough to keep the primary heat chamber heated to a uniform red glow from its top bottom.

3. ADJUSTMENT OF MAXIMUM WICK HEIGHT.

After using the heater over a long period of time, you may observe that flame length in the heat chamber does not reach its normal level several minutes after lighting. When this condition is observed, it means that the wick height needs adjusting using the unique wick life extender.

To adjust the wick height using the wick life extender mechanism, first release the automatic extinguisher by pushing the manual shutoff button.

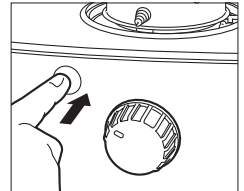

Pull the wick adjuster knob out completely. (It can be removed completely from its shaft.)

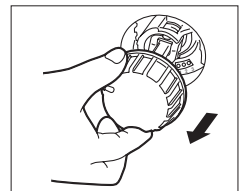

The wick height adjuster knob, with three small holes marked ①, ②, and ③, can be seen. The stem pin is engaged in one of the holes. Pull the control dial toward you and change the location of the pin from ① to ②, or from ② to ③. Each step from pin ① to ② will raise the maximum wick height by 2 mm per step. After this adjustment, replace the wick adjuster knob.

When suitable flame length can no longer be achieved even on pin position 3, it is time to clean and replace the wick. AFTER REPLACING THE WICK, CHECK THE OPERATION OF THE AUTOMATIC EXTINGUISHER BEFORE LIGHTING YOUR HEATER.

NOTE: NEVER use positions ② or ③ until position ① no longer gives adequate flame length.

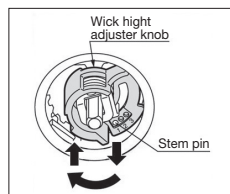

EXTINGUISHING THE FLAME

1. Turn the wick adjuster knob counterclockwise until it stops. This requires about a half turn. At this point, the flame is completely extinguished and the heater is off.

NOTE: DO NOT use the automatic extinguisher to routinely turn off the heater. Automatic extinguishing should occur only when the heater is jarred or tipped. Using the automatic extinguisher to turn off the heater will cause odor, smoke and soot.

2. Make sure the flame is out completely.

3. DO NOT try to relight the heater for at least three (3) minutes after extinguishing it off as this may cause smoke and odor.

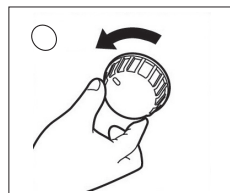

MANUAL SHUTOFF

When quick shutoff is necessary, push the manual shutoff button.

NOTE: For routine turn-off, DO NOT use the Manual Shutoff or activate the Automatic Extinguisher by jarring the heater. These methods may cause unwanted odor, soot and smoke. Only the wick adjuster knob should be used for normal shutoff.

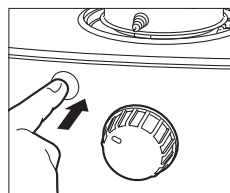

CARE AND MAINTENANCE

As with any good appliance, preventive as well as corrective maintenance is occasionally required. Please read the following section carefully in order to enjoy the greatest benefits from your heater.

INSPECTION OF THE WICK

NOTE: One of the simplest but also the most important components of your heater is the wick.

With proper attention, the wick will last at least one heating season and, depending on the quality of the fuel used, possibly longer, it helps to perform routine maintenance operations on the wick.

1. Indications that the wick may need attention are:

- low flame
- tar deposit on the top edge of the wick
- difficulty in turning the wick adjuster knob
- a flickering or dying flame

2. Clean the wick by burning dry as follows:

1) Lift out the removable fuel tank before turning heater on. Raise the wick to its highest position, ignite heater as usual, and allow the flame to consume the remaining fuel in the fuel sub tank.

NOTE: Burning the wick dry can at times create odors. For the burning dry procedure, remove your heater from the living area of your house into a well-ventilated area such as a garage or even a sheltered area outside. If you burn the wick dry outside, be sure that the heater is not exposed to strong drafts during the procedure.

2) After the heater has cooled completely, remove the cabinet as described in items 1 through 4 of the next section.

3) Remove any residue from the wick with a small brush such as an old toothbrush. Cinders or soot in the burner around the wick may be vacuumed away. Be careful when removing such material from the wick with a brush, to do so gently so as not to tear the top surface of the wick.

4) Remove any tar deposits on the top of wick holder and primary air tube using a scraper.

NOTE: When good wick performance is no longer achieved by the burning dry process, it may be necessary to replace the burned wick with a new one.

5) Before reassembling the heater, take a few minutes to wipe the parts with a soft cotton cloth or paper towels.

6) Reassemble the heater, following directions in item 15 of the next section.

NOTE: If the flame is still low after cleaning the wick, the wick may contain some water. It is then necessary to replace the wick and empty all kerosene from the removable fuel tank and the fuel sub tank. Dry the tank thoroughly and refill with fresh, pure kerosene.

CHECK THE FUEL ACCEPTANCE FITTING

Regarding the heater assembled the fuel acceptance fitting with the fuel filter, when dirt or dust accumulates in the fuel acceptance fitting, it should be cleaned. Check the fuel acceptance fitting each time your refuel.

REPLACEMENT OF PARTS

REPLACING THE WICK

⚠ WARNING: Before disassembling your heater, allow it to cool completely.

1. Remove the fuel tank assembly out of tank.
And remove the four (4) batteries out of battery holder.

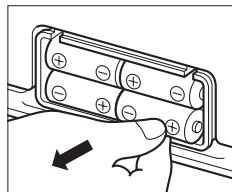
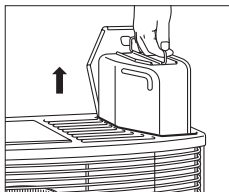

2. After the heat chamber has cooled completely, push the manual shutoff button first, open the grille and remove the heat chamber.

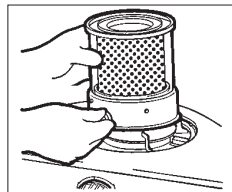
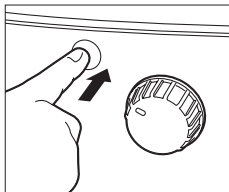

3. Pull out the wick adjuster knob from the wick adjuster shaft.

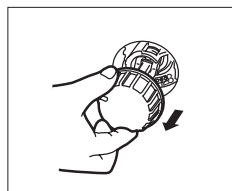

4. Remove the three (3) screws at the side and rear of the cabinet by using the screwdriver, and lift the cabinet off, bringing it slightly forward.

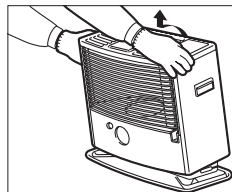
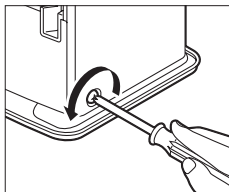

5. Remove the four (4) wing nuts around the wick holder.

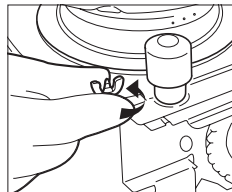

6. Lift the wick holder off the heater.

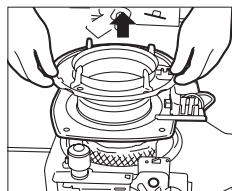

7. Place the knurled wick adjustment knob on the wick mechanism. Turn the knob as far to the right as possible.

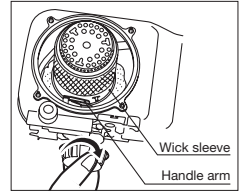

8. Turn the wick sleeve counterclockwise and lift the wick sleeve with wick up. Remove it from the primary air tube.

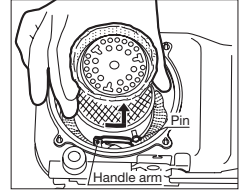

9. Squeeze the wick to loosen the three wick pins and remove the wick from the wick sleeve. Ensure that you are wearing gloves and that you have a container in which to put the kerosene wick. Install the new wick to the wick sleeve according to the allowed direction engraved on the wick sleeve.

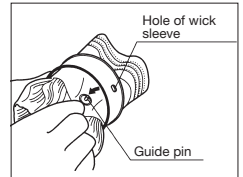

NOTE: Install the wick to the wick sleeve according to the allowed direction engraved on the sleeve.

Engraved mark

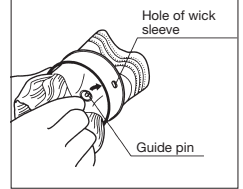

10. Install the wick sleeve with wick to the primary air tube. And then turn the wick sleeve clockwise to set the handle arm.

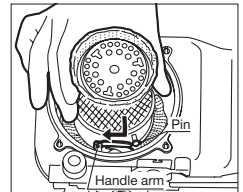
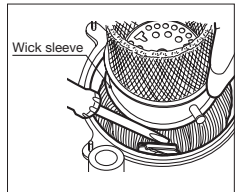

11. Operate the wick adjuster knob to be sure the wick moves smoothly up and down.

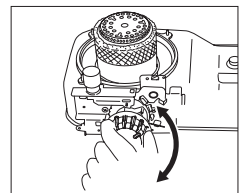

12. Put the wick holder back into position.

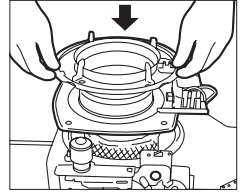

13. Make certain the top plate of the wick holder and the top of primary air tube are the same height. If they are uneven, the flames tend to be uneven, too. And tighten the four (4) wing nuts around the wick holder.

Note: The space between the wick holder and the primary air tube should be even all around.

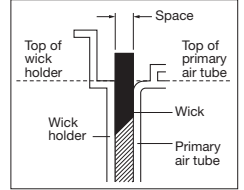
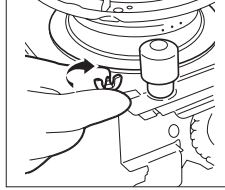

14. Operate the wick adjuster knob to be sure the wick moves smoothly up and down. After replacing the wick, check the operation of the automatic extinguisher.



15. Wick height on position ① of wick life extender should be 8 mm (5/16 in.) when wick adjuster knob fully clockwise. Be sure to check. Pull out the wick adjuster knob from the wick adjuster shaft.

16. Replace the cabinet and secure it into position.

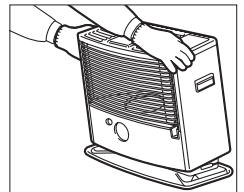

17. Tighten the three (3) screws at the side and rear of the cabinet by using the screwdriver.

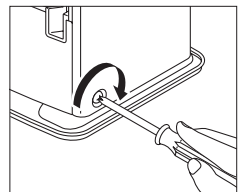

19. Replace the wick adjuster knob on the wick adjuster shaft.

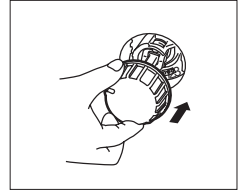

20. Install the heat chamber. Grasp the wire handle, then turn the heat chamber left and right to ensure that it is properly seated. Once again check the proper operation of the automatic extinguisher. Put the batteries into the battery holder.

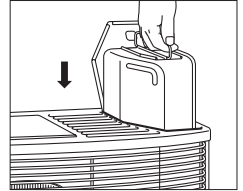
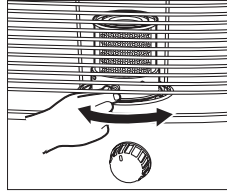

21. Before lighting a new wick for the first time, turn the wick to its lowest position. Allow the wick to saturate with kerosene for about thirty (30) minutes.

STORAGE

At the end of each heating season, or when you do not plan to use your heater for an extended period of time, the following procedures are recommended.

1. DRAIN FUEL SUB TANK

After you have burned your heater dry, a small amount of kerosene (paraffin) will remain in the fuel tank. It should be removed in order to avoid contamination when the heater is refueled at a later date. To do this, disassemble the heater as described in items, 1 through 4 under "REPLACING THE WICK". Remove the fuel acceptance fitting from the hole in the fuel sub tank.

Tilt the drip tray toward the hole, and remove the remaining kerosene (paraffin) with a siphon or a small syringe.

Replace the fuel acceptance fitting.

Replace the cabinet and the heat chamber.

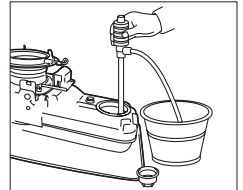

2. REMOVE BATTERIES FROM BATTERY HOLDER

3. STORE HEATER

The original shipping carton is the best place to store your heater. If you do not have original packing materials, cover the heater with a large plastic bag and store in a dry place.

SPECIFICATIONS

TOYOTOMI Portable Kerosene (paraffin) Heater

Model RCA-37 (Type B)

Heat rating

10,300 BTU/h (2,600 kcal/h)

Fuel tank capacity

4.7

Burning time / tank*

16.8 Hours

Size (W × D × H)

586 × 304 × 439 mm

Weight

9.5 kg

Wick adjuster

Wick life extender mechanism

Igniter

Automatic, powered by four (4) "C" size batteries

* Depending on wick setting, condition and fuel quality.

COMPONENT PARTS

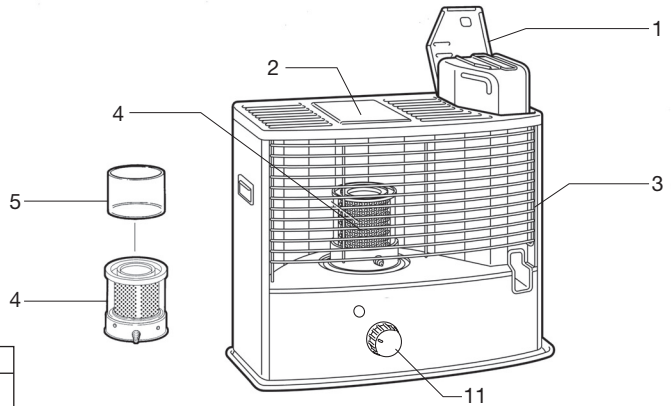

REF #	PART NAME
1.	Tank lid
2.	Top plate
3.	Grille
4.	Heat chamber assembly
5.	Glass cylinder
6.	Removable fuel tank
7.	Fuel tank cap
8.	Wick holder
9.	Igniter unit
10.	Pendulum assembly
11.	Wick adjuster knob
12.	Glass fiber wick
13.	Wick sleeve
14.	Rubber packing
15.	Fuel sub tank
16.	Fuel acceptance fitting
17.	Drip tray
18.	Battery holder
19.	Manual fuel siphon

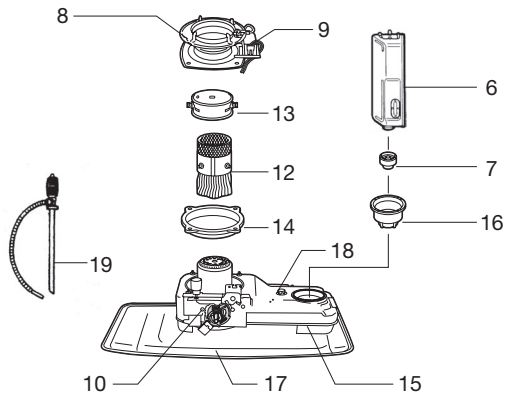

Disposal of old Electrical & Electronic Equipment (Applicable in the European Union and other European countries with separate collection systems).

This symbol on the product or on its packaging indicates that this product shall not be treated as household waste. Instead it shall be handed over to the applicable collection point for the recycling of electrical and electronic equipment. By ensuring this product is disposed of correctly, you will help prevent potential negative consequences for the environment and human health, which could otherwise be caused by inappropriate waste

handling of this product. The recycling of materials will help to conserve natural resources. For more detailed information about recycling of this product, please contact your local city of. ce, your household waste disposal service or the shop where you purchased the product.

TOYOTOMI

TOYOTOMI CO., LTD.

5-17, Momozono-cho
Mizuho-ku, Nagoya, Japan

www.toyotomi.jp

Rev. 04/19

Printed in Japan
0294000903